

- ※ Complimentary to S9015
- ※ Collector Current:  $I_c=100\text{mA}$

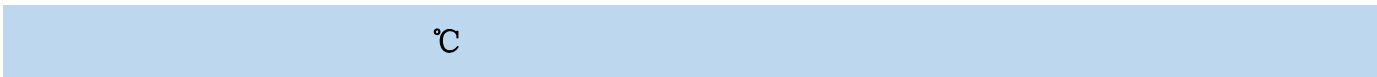

Parameter	Symbol	Value	Unit
Collector-Base Voltage	VCBO	60	V
Collector-Emitter Voltage	VCEO	50	V
Emitter-Base Voltage	VEBO	5	V
Collector Current	IC	100	mA
Collector Power Dissipation	PC	200	mW
Thermal Resistance From Junction To Ambient	RθJA	625	°C/W
Junction Temperature	Tj	150	°C
Storage Temperature	Tstg	-55~+150	°C



Collector-base breakdown voltage	V(BR)CBO	IC= 100μA, IE=0	60		V
Collector-emitter breakdown voltage	V(BR)CEO	IC= 1mA, IB=0	50		V rT
Emitter-base breakdown voltage	V(BR)EBO	IE= 100μA, IC=0	5		V
Collector cut-off current	ICBO	VCB= 60 V , IE=0		0.1	μA
Collector cut-off current	ICEO	VCB= 50V , IE=0		0.1	μA
Emitter cut-off current	IEBO	VEB= 6V , IC=0		0.1	μA
DC current gain	hFE	VCE=6V, IC= 1mA	200	450	
	hFE	VCE=6V, IC= 10mA	100		
Collector-emitter saturation voltage	VCE(sat)	IC=100 mA, IB= 10mA		0.3	V
Base-emitter saturation voltage	VBE(sat)	IC=100 mA, IB= 10mA		1e8	0 V
Transition frequency					

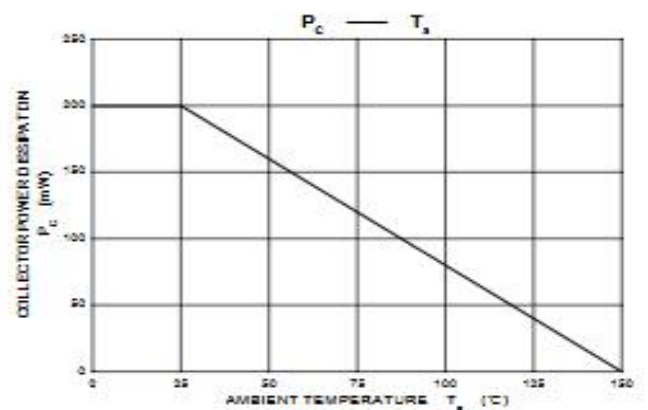
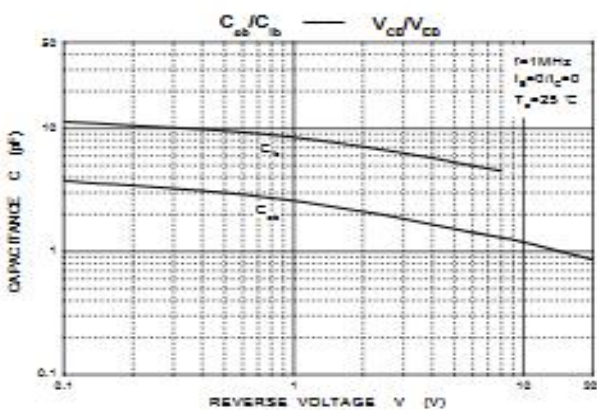
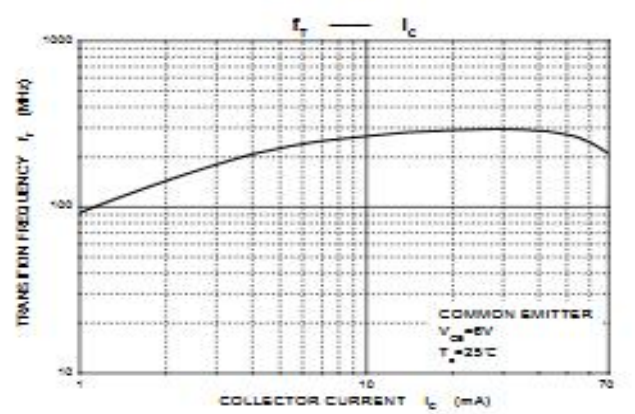
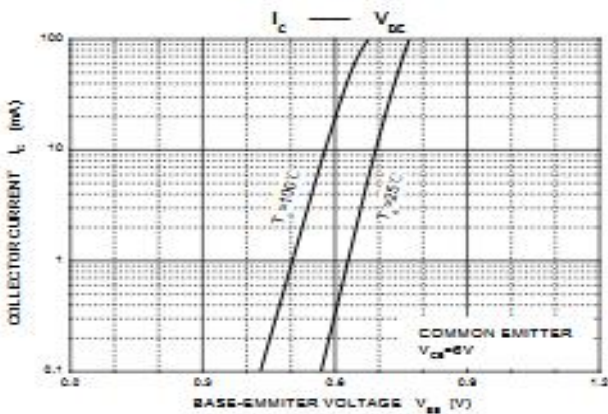
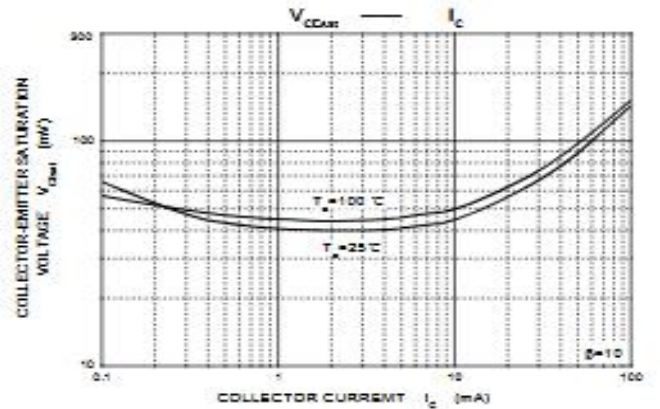
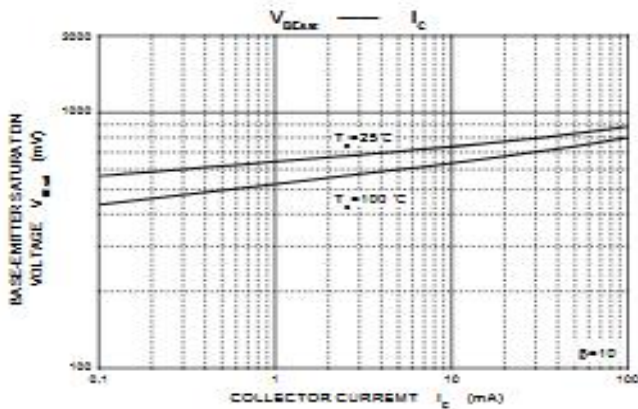
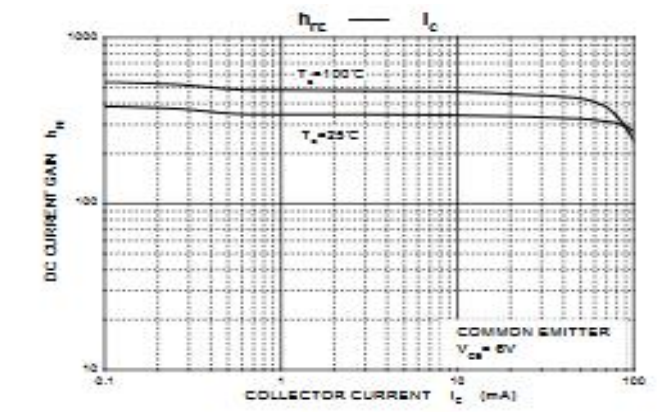
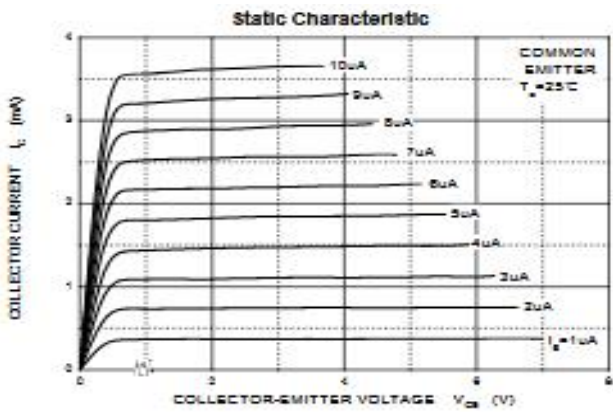



### SOT-23 PACKAGE OUTLINE DIMENSIONS

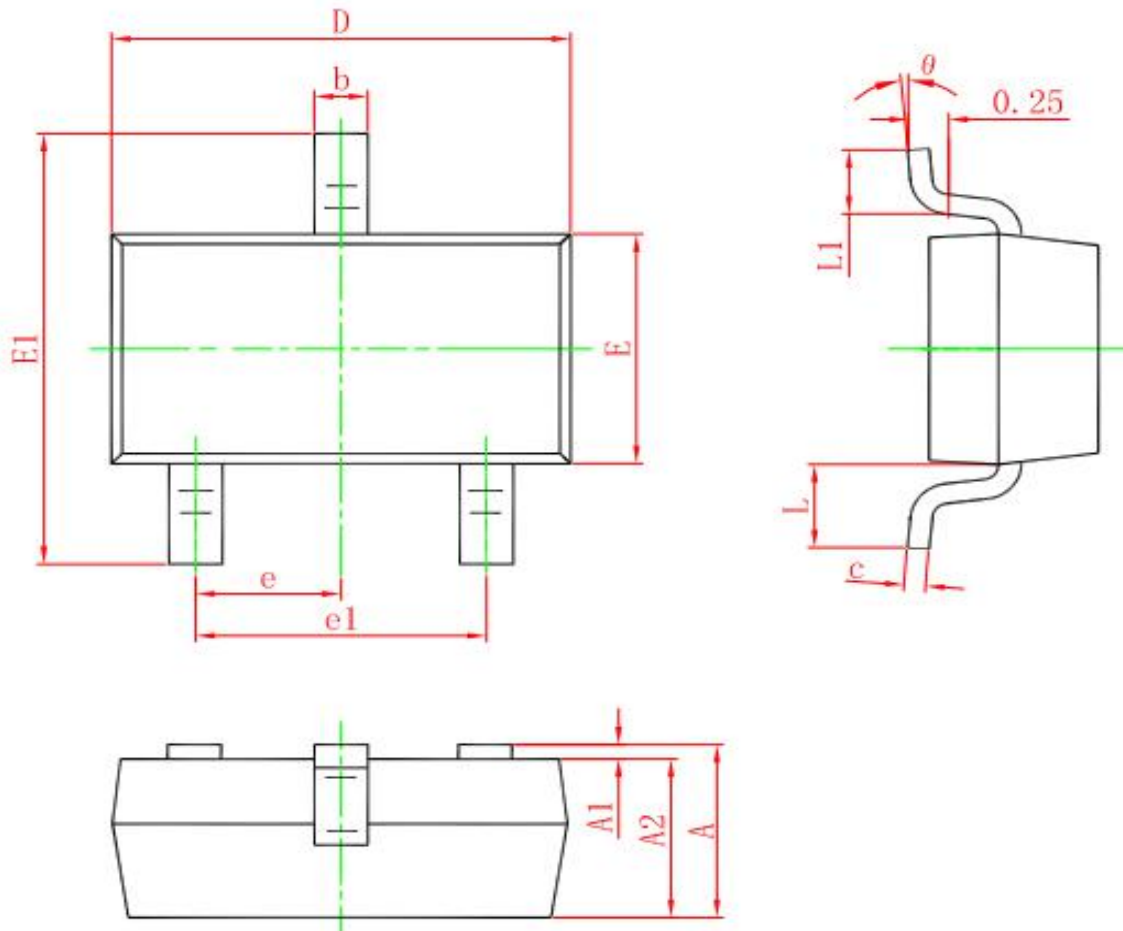

Symbol	Dimensions In Millimeters		Dimensions In Inches	
	Min.	Max.	Min.	Max.
A	0.900	1.150	0.035	0.045
A1	0.000	0.100	0.000	0.004
A2	0.900	1.050	0.035	0.041
b	0.300	0.500	0.012	0.020
c	0.080	0.150	0.003	0.006
D	2.800	3.000	0.110	0.118
E	1.200	1.400	0.047	0.055
E1	2.250	2.550	0.089	0.100
e	0.950 TYP.		0.037 TYP.	
e1	1.800	2.000	0.071	0.079
L	0.550 REF.		0.022 REF.	
L1	0.300	0.500	0.012	0.020
θ	0°	8°	0°	8°